

TWIST LOCK SEAT SWITCHES

Model Series 6500/6544 Series



- Conventional twist mount
- No fasteners
- Easy to install and connect
- RoHS, REACH and Conflict Mineral compliant

OPERATION

Delta's seat switches are utilized to sense operator presence. When a seated operator compresses the seat foam, the switch is actuated. Seat safety switches are easy to integrate into your application and designed to last in harsh surroundings. Typical applications include construction equipment, material handling equipment, outdoor power equipment, forklifts, rental equipment, agricultural equipment, ATVs, UTVs and other applications where operator presence detection is necessary.

ELECTRICAL SPECIFICATION

Max Operating Voltage, 18V_{DC}
 Max Current @ 12-14 V_{DC}, 3A
 Pre-travel .040-.150 inches
 Contact Resistance @ Max Current, 83.3 mΩ
 Cycle Life @ Max Load Inductive 10,000, Resistive 75,000
 Operating /Storage Temperature, -20 °F to +150 °F
 Installation Temperature, -20 °F to +100 °F

ENVIRONMENTAL RATINGS

Exposure	Specification
Salt Fog	ASTM B117. 96 hours
Chemical Resistance	ASTM Ref C Fuel, Diesel Fuel, Oil, Antifreeze, Freon, Paint, Latex, Gasoline, Gas with 10% ethanol, WD-40, Battery Acid, Ammoniated Glass Cleaner, Kerosene, GOJO®, Fertilizer

AVAILABLE CONFIGURATIONS

Product Line	Part number	Electrical Configuration	Mounting Style	Actuation Force	Connector
Plungers - Seat	6500-01	NO	Twist Lock, 3.3" Dia	5.0 +/- 1.5 @ .250"	N/A Terminals Only
Plungers - Seat	6500-02	NO	Twist Lock, 3.3" Dia	4.0 +/- 1.0 @ .300"	Delta 96525 or 96526
Plungers - Seat	6500-03	NO	Twist Lock, 3.3" Dia	5.0 +/- 1.5 @ .250"	Delta 96525 or 96526
Plungers - Seat	6500-04	NO	Twist Lock, 3.3" Dia	4.0 +/- 1.0 @ .300"	Delta 96525 or 96526
Plungers - Seat	6500-04FR	NO	Twist Lock, 3.3" Dia	5.0 +/- 1.5 @ .250"	Delta 96525 or 96526
Plungers - Seat	6500-51	NC	Twist Lock, 3.3" Dia	5.0 +/- 1.5 @ .250"	N/A Terminals Only
Plungers - Seat	6500-52	NC	Twist Lock, 3.3" Dia	5.0 +/- 1.5 @ .250"	Delta 96525
Plungers - Seat	6500-52FR*	NC	Twist Lock, 3.3" Dia	5.0 +/- 1.5 @ .250"	Delta 96525
Plungers - Seat	6500-54	NC	Twist Lock, 3.3" Dia	4.0 +/- 1.0 @ .300"	Delta 96525
Plungers - Seat	6500-56	NC	Twist Lock, 3.3" Dia	4.0 +/- 1.0 @ .300"	Delta 96525
Plungers - Seat	6500-57	NO	Twist Lock, 3.3" Dia	5.0 +/- 1.5 @ .250"	Delta 96525
Plungers - Seat	6544-02	NO\NO	Twist Lock, 3.3" Dia	2.5 +/- 1.0 @ .250"	Delta 96546
Plungers - Seat	6544-03	NC\NC	Twist Lock, 3.3" Dia	2.5 +/- 1.0 @ .250"	Delta 96525 or 96526
Plungers - Seat	6544-53	NC\NO	Twist Lock, 3.3" Dia	2.5 +/- 1.0 @ .250"	Delta 96525 or 96526
Plungers - Seat	6544-53FR*	NC\NO	Twist Lock, 3.3" Dia	2.5 +/- 1.0 @ .250"	Delta 96546
Plungers - Seat	6544-602	NO\NO	Twist Lock, 3.3" Dia	5.0 +/- 1.5 @ .250"	Delta 96546
Plungers - Seat	6544-603	NC\NC	Twist Lock, 3.3" Dia	5.0 +/- 1.5 @ .250"	Delta 96525 or 96526
Plungers - Seat	6544-653	NC\NO	Twist Lock, 3.3" Dia	5.0 +/- 1.5 @ .250"	Delta 96525 or 96526
Plungers - Seat	6544-683	NC\NC	Twist Lock, 3.3" Dia	5.0 +/- 1.5 @ .250"	Delta 96549
Plungers - Seat	6544-902	NO\NO	Twist Lock, 3.3" Dia	7.0 +/- 1.5 @ .250"	Delta 96546
Plungers - Seat	6544-983	NC\NC	Twist Lock, 3.3" Dia	7.0 +/- 1.5 @ .250"	Delta 96549

* UL Recognized Component to UL583 (Listing # AU3028)

Note: Life expectancy and switch performance are largely dependent on application. It is the user's responsibility to determine suitability of this product for the application. This information is intended as a guide for proper application.

TWIST LOCK SEAT SWITCHES

Model Series 6500/6544

DIMENSIONS

Note: For specific Part information please refer to the Application print.

6500 Series

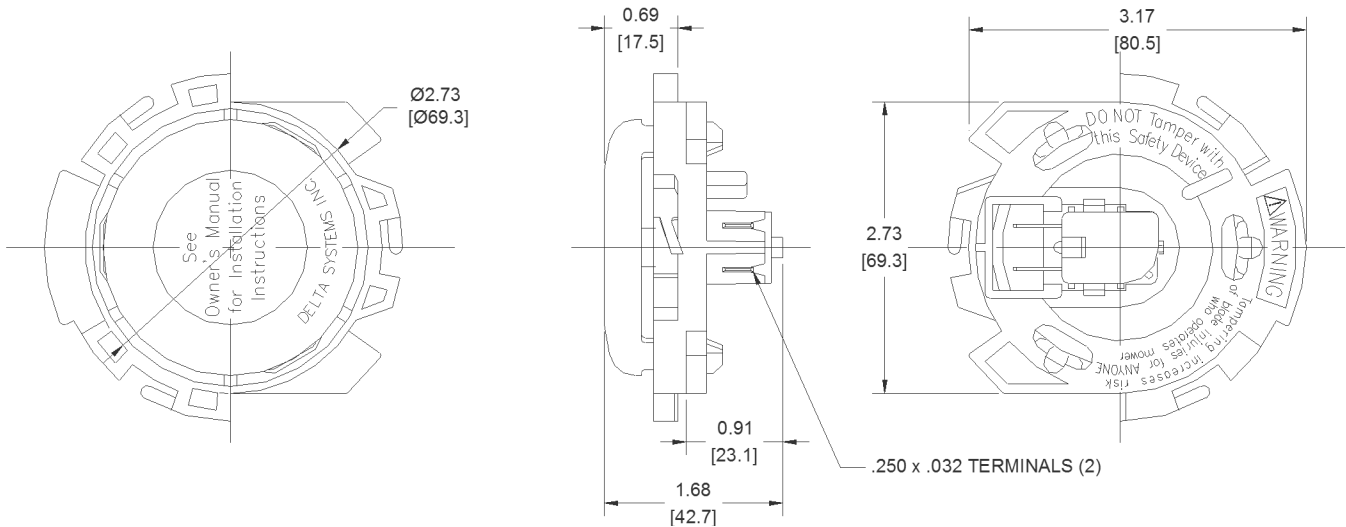

6544 Series

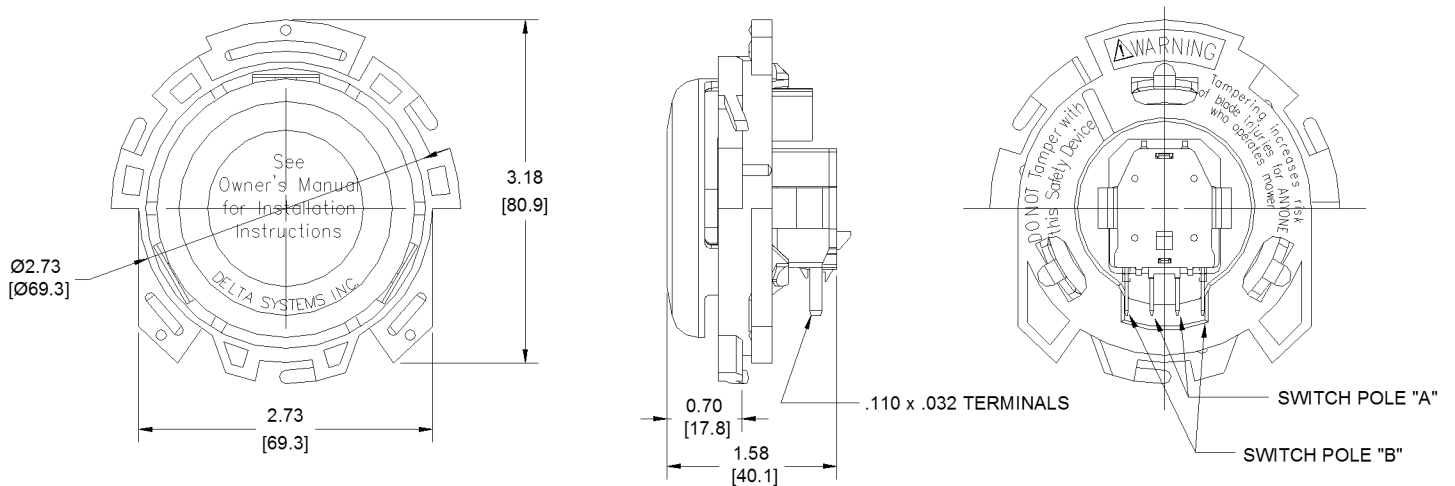

CONNECTIONS

6500 series switches connect to Delta P/N 96525 or 96526 (see Accessories section). Insertion force is up to 20 lbs. Delta connectors use Delphi terminals.

6544 series switches connect to Delta P/N's 96545 or 96546 (see Accessories section). Connection effort is 10 to 22 lbs. Delta connectors use Delphi terminals.

MOUNTING

Locks in place with a 55° rotation. Recommended panel thickness is .040-.070.

Recommended cutout dimensions are:

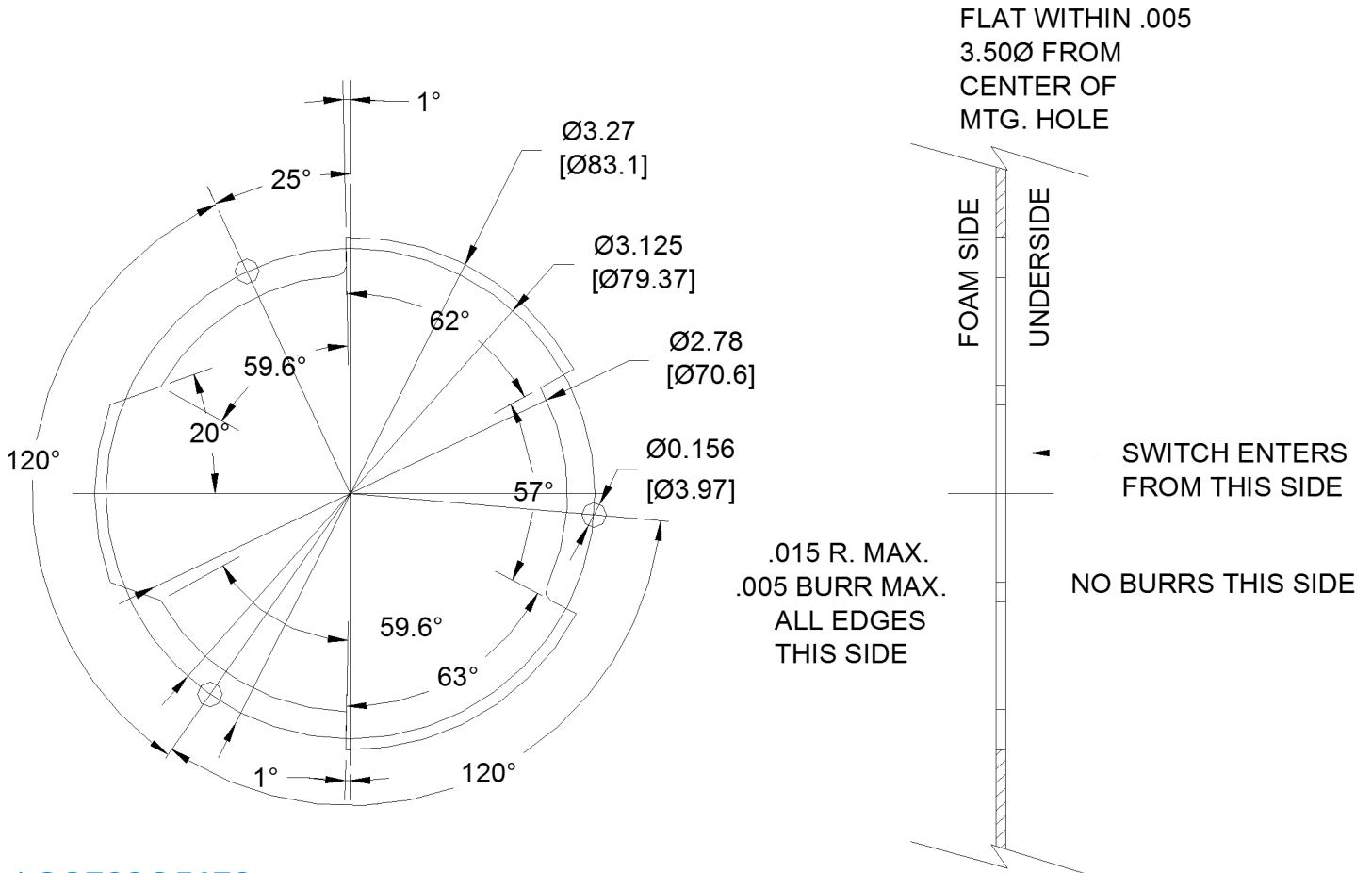

ACCESSORIES

Item #	Manufacturer	Description
96545(-BK/-GY)	Delta Systems	Connector Housing, Shorting
96546(-BK/-GY)	Delta Systems	Connector Housing, Non-Shorting
12034046	Delphi	Terminal, 18-20 Gage Wire
12066214	Delphi	Terminal, 14-16 Gage Wire
96525-GY	Delta Systems	Connector Housing, Shorting
96526(-GY/-OL)	Delta Systems	Connector Housing, Non-Shorting
96526A	Delta Systems	Connector Housing, Non-Shorting
12124517	Delphi	Terminal, 18-20 Gage Wire
12124513	Delphi	Terminal, 14-16 Gage Wire