

REVISIONS			
X4	INITIAL RELEASE, CR 1716	11/05/07	DAS

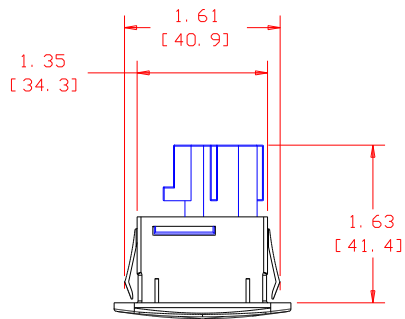

RECOMMENDED MOUNTING HOLE

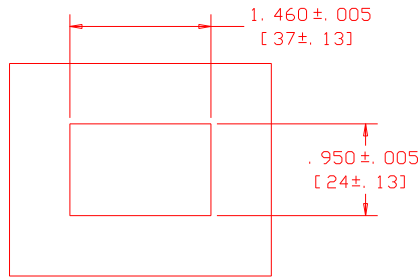

TOTAL MOUNTING PANEL THICKNESS
 RANGE: 0.060 - 0.200 IN.
 [1.52 - 5.08]
 RECOMMENDED CUSTOMER PANEL SHOULD BE
 DESIGNED & MANUFACTURED SO THAT METER
 MOUNTING WINGS ENGAGE WITH A SQUARE EDGE

METER DATE CODED
 ON LONG FACE,
 EITHER SIDE

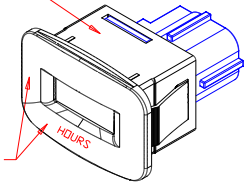

TOP FACE TEXTURED PER
 MAKIND 26R MAX. OR
 EQUIVALENT (SUCH AS
 MT11070)

— * 4.5 DIGIT DISPLAY TO TENTHS OF HOURS
 * FLASHING DECIMAL POINT WHILE IN USE

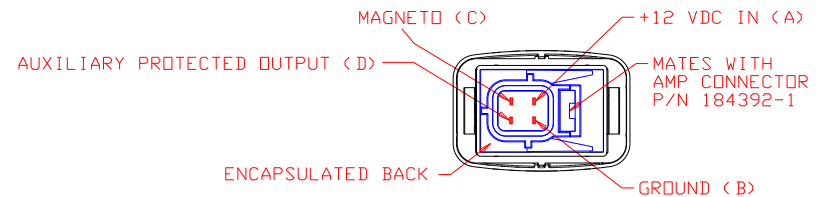
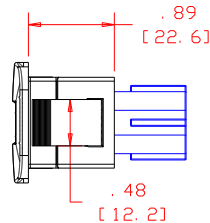
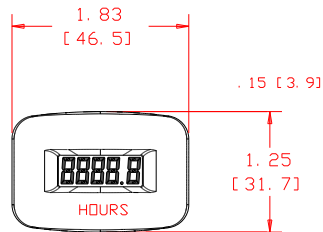

NOTES:

- DIMENSIONS IN BRACKETS [] ARE IN MILLIMETERS. MILLIMETER TOLERANCES ARE: 0.X±0.5, 0.XX±0.15
- HOUSING IS CLEAR POLYCARBONATE. BACK CONNECTOR IS BLACK ABS. FACEPLATE IS BLACK POLYCARBONATE/ABS.
- ASSEMBLY SEALED WITH ENCAPSULANT, DESICCANT INSIDE.
- ASSEMBLY DATE CODED TO YEAR, MONTH, AND DAY OF MANUFACTURE PER DELTA MFG. SPEC. #1640
- THIS PRODUCT COVERED BY ONE OR MORE OF THE FOLLOWING U.S. PATENTS: 4,294,327; 4,369,745; 5,190,019.
- OPERATING VOLTAGE: +9 TO +16 VDC.
- OPERATING TEMPERATURE RANGE: -30 TO +80 °C.
- OPTIMUM VIEWING ANGLE, 12:00.
- AUXILIARY OUTPUT RATING: 1.0 AMPS DC, MAXIMUM
- COMPATIBLE MATING CONNECTORS:
 AMP P/N 184246-1(WITHOUT LOCKING FEATURE),
 AMP P/N 184248-1(WITH SECONDARY LOCK)
- SERVICE REMINDER: THE DISPLAY FLASHES 'CHG' THEN 'OIL' THEN 'HOURS DATA'. THIS OCCURS EVERY 50 HOURS AND LASTS FOR 2 HOURS, I.E. FROM 50.0 TO 52.0 HOURS. USER CANNOT RESET SERVICE REMINDER

Preliminary Drawing
 (Samples do not have service reminder feature)

DELTA SYSTEMS, INC. DOES NOT ASSUME ANY LIABILITY ARISING OUT OF THE MISAPPLICATION OF ANY PRODUCT		DRAWN JDW DATE 10/09/07	 DELTA SYSTEMS INC. STREETSBORO, OHIO 44241
COMPUTER GENERATED DRAWING - NO MANUAL CHANGES ALLOWED		CHECKED XX DATE 07	TITLE HOURMETER - SMARTGARD MAG SENSING WITH PROTECTED 12V
UNLESS OTHERWISE SPECIFIED DIMENSIONS ARE IN INCHES TOLERANCES ARE: .XX± .02 .XXX± .005 ANG± 1° DO NOT SCALE DRAWING		MATERIAL AS NOTED	SIZE C DWG. NO. 2014-303
FINISH AS NOTED		SCALE FULL	PROJECT NO. EX361 REV X4