

USE 2 REACTION
PINS, TOP OR BOTTOM

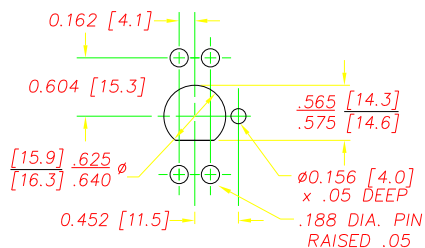

RECOMMENDED PLASTIC PANEL
MOUNTING HOLE
(VIEW FROM BACK OF PANEL)

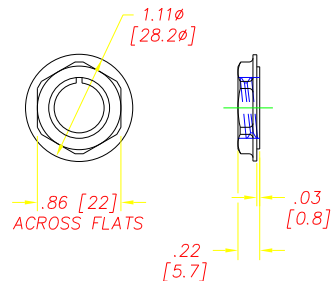

NUT DETAILS
(DSI P/N 9256)
PANEL THICKNESS RANGE .07 TO .19

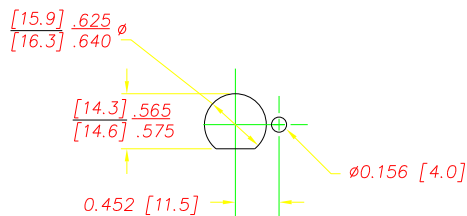

RECOMMENDED METAL PANEL
MOUNTING HOLE
(VIEW FROM BACK OF PANEL)

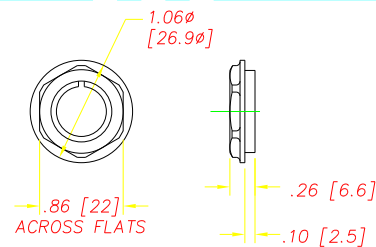

NUT DETAILS
(DSI# 9252)
MATES WITH ACCURATE MOLD &
DIE CO. BEZEL# 121
PANEL THICKNESS RANGE .05 TO .17

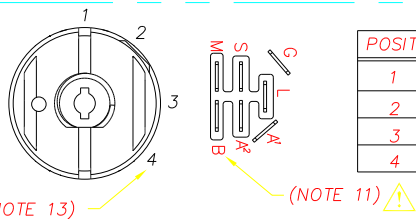

POSITION	ROTATION	FUNCTION	CONTACT 1	CONTACT 2
1	0°	OFF	M+G+A ¹	~
2	45°	RUN1	B+A ¹	L+A ²
3	95°	RUN2	B+A ¹	~
4	135°	START	B+S+A ¹	~

NOTES

- 1-DIM.'S IN BRACKET [] ARE IN MILLIMETERS; MILLIMETER TOLERANCES ARE .X± .5, .XX± .15.
- 2-PLASTIC PARTS ARE DELTON™ (BLACK HOUSING, GRAY BACK COVER). TERMINALS ARE BRONZE.
- 3-7/8 HEX NUT IS SHIPPED SEPARATELY.
- 4-RECOMMENDED ASSEMBLY TORQUE IS 26 IN-LBS TO 36 IN-LBS. AUTOMATIC SHUTOFF TORQUE SCREWDRIVER MAXIMUM SPEED IS 300 RPM.
- 5-KEY IS SHIPPED SEPARATELY. MAXIMUM TORQUE FOR KEY IS 20 IN LBS. USE DELTA KEY ONLY. DELTA STEEL KEY PART# 688S-STD.
- 6-SWITCH STYLE STAMPED ON HOUSING.
- 7-DATE CODE INDICATING YEAR, MONTH, AND DAY OF MONTH MANUFACTURED STAMPED ON HOUSING.
- 8-SWITCH ELECTRICAL FUNCTIONALITY TESTED AFTER ASSEMBLY.
- 9-ELECTRICAL RATING, CONTINUOUS: 20A @ 12-14 VDC. ELECTRICAL LIFE: 5K CYCLES @ 10 AMPS INDUCTIVE. 10K CYCLES @ 5 AMPS INDUCTIVE. 50K CYCLES @ 5 AMPS RESISTIVE.
- 10-THIS PRODUCT COVERED BY THE FOLLOWING U.S. PATENT: 5,252,791. OTHER PATENTS APPLIED FOR.
- 11-SWITCH SHOULD NEVER BE MOUNTED IN PANEL WITH THE "B" TERMINAL DIRECTLY ABOVE THE "G" TERMINAL, RELATIVE TO GRAVITY.
- 12-PULL FORCE TO DISLOCATE BACK COVER IS 80 LBS. MINIMUM.
- 13-POSITION 4 IS MOMENTARY.
- 14-ALL OTHER CONTACT COMBINATIONS ARE NOT ALLOWED.

REVISIONS			
A	REVISED PIN LOCATION, CR943	05/23/97	TW
B	REVISED BACK COVER, CR 1018	08/15/97	TW
C	REVISED BACK COVER, CR 1046	9/17/97	JH
D	ADDED CONNECTOR STOP, CR1215	12/11/98	JH
E	REM'D CORE IN BACKCOVER, CR 1306	06/04/99	JH
F	UPDATED NOTE, MATERIAL IS BRONZE	7/13/99	ML
G	ADDED TAPER PER CR1334	9/9/99	JH
H	DEFINED CRITICAL CHARACTERISTICS	05/08/00	JH
I	BACK COVER COLOR CHANGE, CR1384	09/11/00	JH
J	DIM .62 [15.7] TO .60 [15.2], CNO554	09/09/02	JG
K	REMOVE CRITICAL DIM., CR 1477	06/02/03	JH

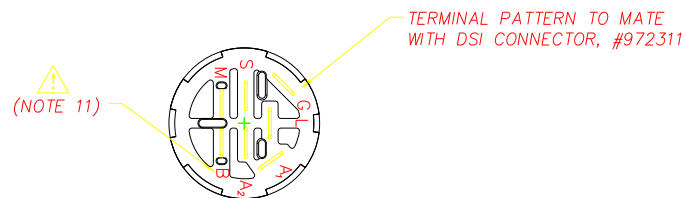
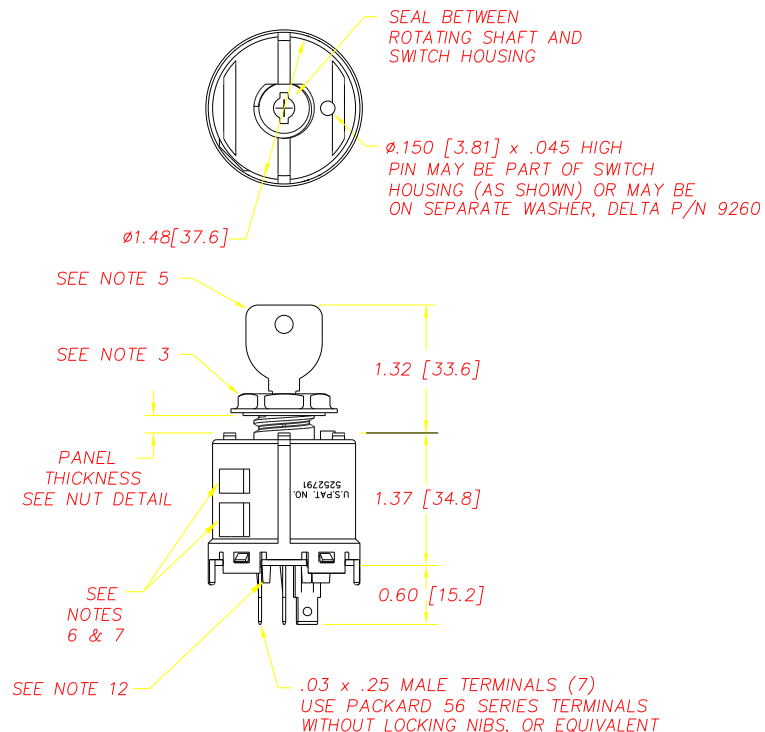

DELTA
SYSTEMS INC.
STREETSBORO, OHIO 44241

DELTA
SYSTEMS INC.

TITLE: IGNITION SWITCH
4 - POSITION

SIZE: C DWG. NO: 6850-47

SCALE: FULL PROJECT NO: EX311 REV: K

DELTA SYSTEMS, INC. DOES NOT ASSUME ANY LIABILITY ARISING OUT OF THE MISAPPLICATION OF ANY PRODUCT

DRAWN: BAP DATE: 10/04/96
CHECKED: TW DATE: 11/04/96

MATERIAL: SEE NOTE 2

FINISH: SEE NOTE 2

UNLESS OTHERWISE SPECIFIED DIMENSIONS ARE IN INCHES TOLERANCES ARE:
.XX± .02 .XXX± .005 ANG± 1°

COMPUTER GENERATED DRAWING - NO MANUAL CHANGES ALLOWED

DO NOT SCALE DRAWING